



Iyer  
Practice  
ADVISERS

---

# Introduction to International Tax Planning

---

Sanjay Iyer  
21 November 2014

SINGAPORE | HONGKONG  
20 YEARS IN PRACTICE



Iyer  
Practice  
ADVISERS

# AGENDA

1. Background
2. Tax Evasion, Avoidance & Planning
3. Source V. Residence Rule
4. Allocation of Taxing Rights
5. Reducing Foreign Tax Liability – OECD Articles
6. Other Matters
7. Transfer Pricing

SINGAPORE | HONGKONG  
20 YEARS IN PRACTICE



**BACKGROUND**

# What is International Tax?

- Allocation of taxing rights between two or more jurisdictions.

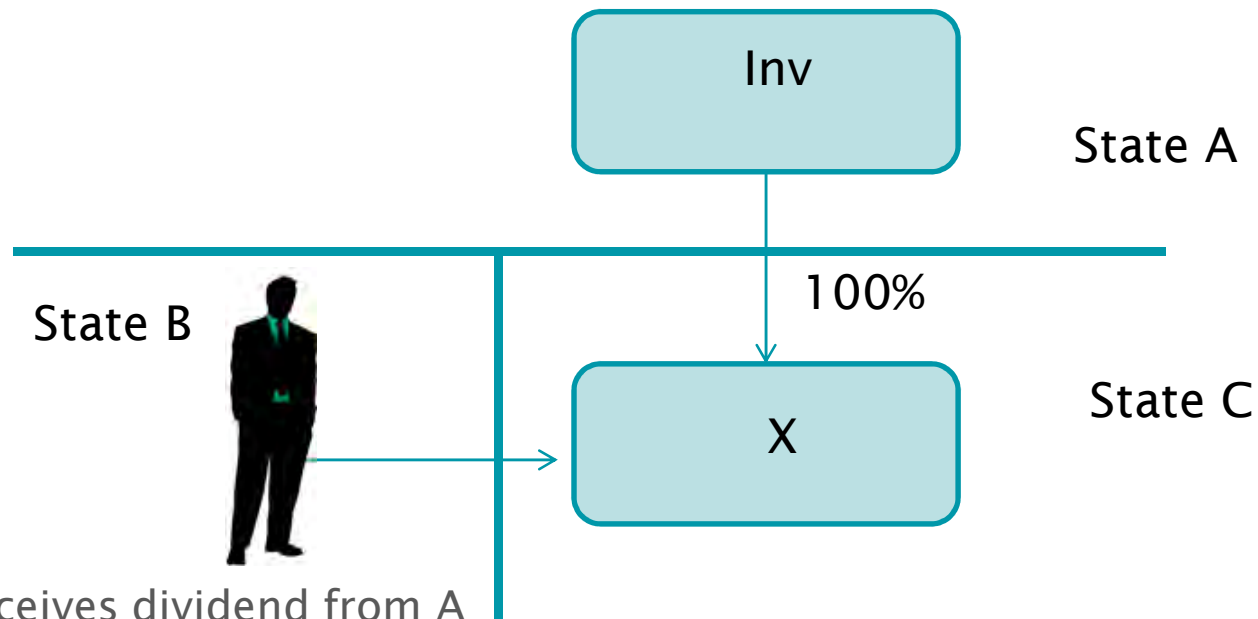

- 'C' receives dividend from A
- 'C' receives service income from B

**Who has the right to tax the dividend and service income?**

# International Tax Planning



- Structuring of cross border business/ transaction in the most tax efficient manner
  - ✓ Domestic tax law
  - ✓ Tax Treaties
  - ✓ EU tax law



# TAX EVASION, AVOIDANCE & PLANNING



# Understanding the difference

- Evasion
- Avoidance
- Planning
- Tax planning -upheld by various courts - is allowed
- Helvering V. Gregory, 69F.2d 809 - Judge Learned Hand
- *“Anyone may arrange his affairs so that his taxes shall be as low as possible; he is not bound to choose that pattern which best pays the Treasury. There is not even a patriotic duty to increase one’s taxes. Over and over again the courts have said that there is nothing sinister in so arranging affairs as to keep taxes as low as possible. Everyone does it, rich and poor alike and all do right, for nobody owes any public duty to pay more than the law demands”.*
- Vodafone, Starbucks, Google and Apple



# SOURCE V. RESIDENCE RULE



# The Source Rule: Primary Taxing Rights

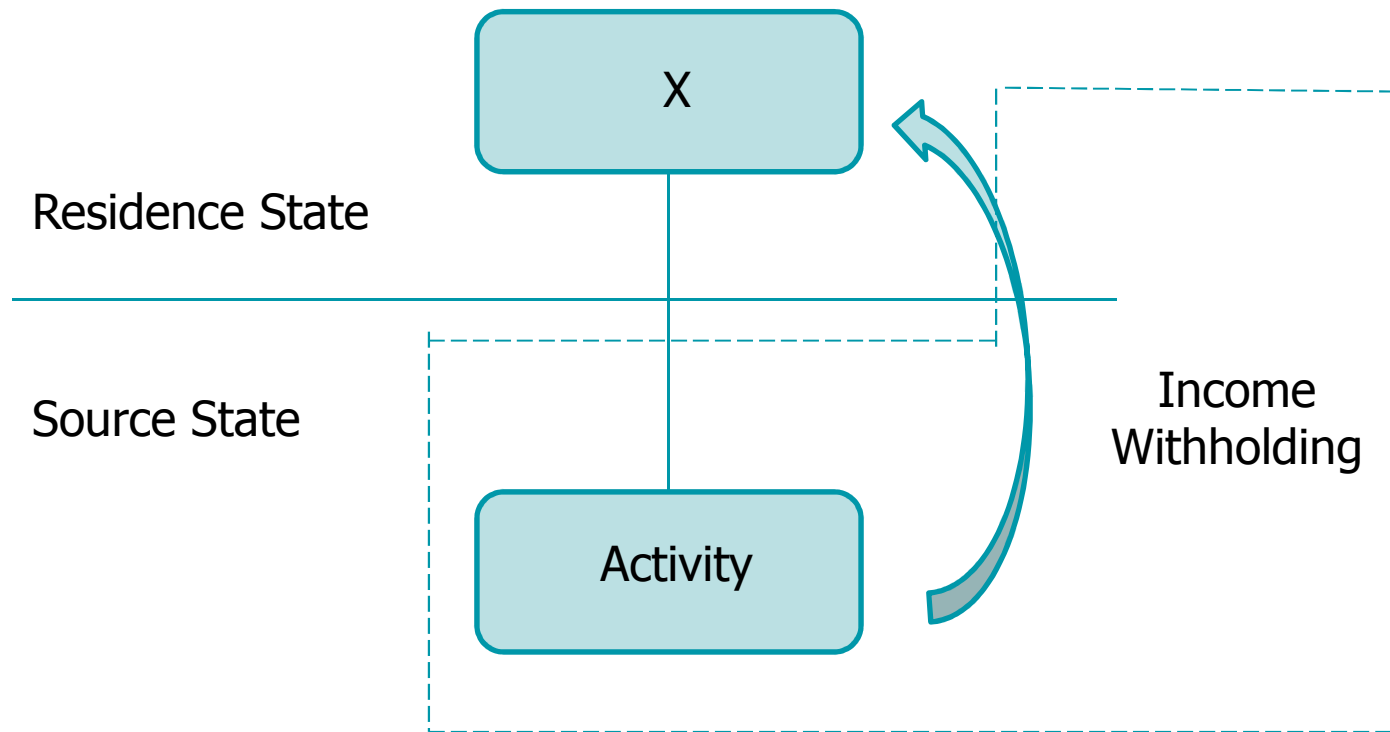

# The Source Rule: Primary Taxing Rights



- Income of a person whether earned or otherwise, irrespective of his residence will be taxed in the source state
- most countries levy withholding taxes on income sourced in their jurisdiction
- Withholding tax is a preliminary tax imposed at source, and is widely applied in respect of almost all sorts of payments including royalties, dividends, capital gains, salaries, interest etc.
- US is known to have the most developed/aggressive wth tax rules with taxes as high as 30%

# The Residence Rule: Right to Tax Income

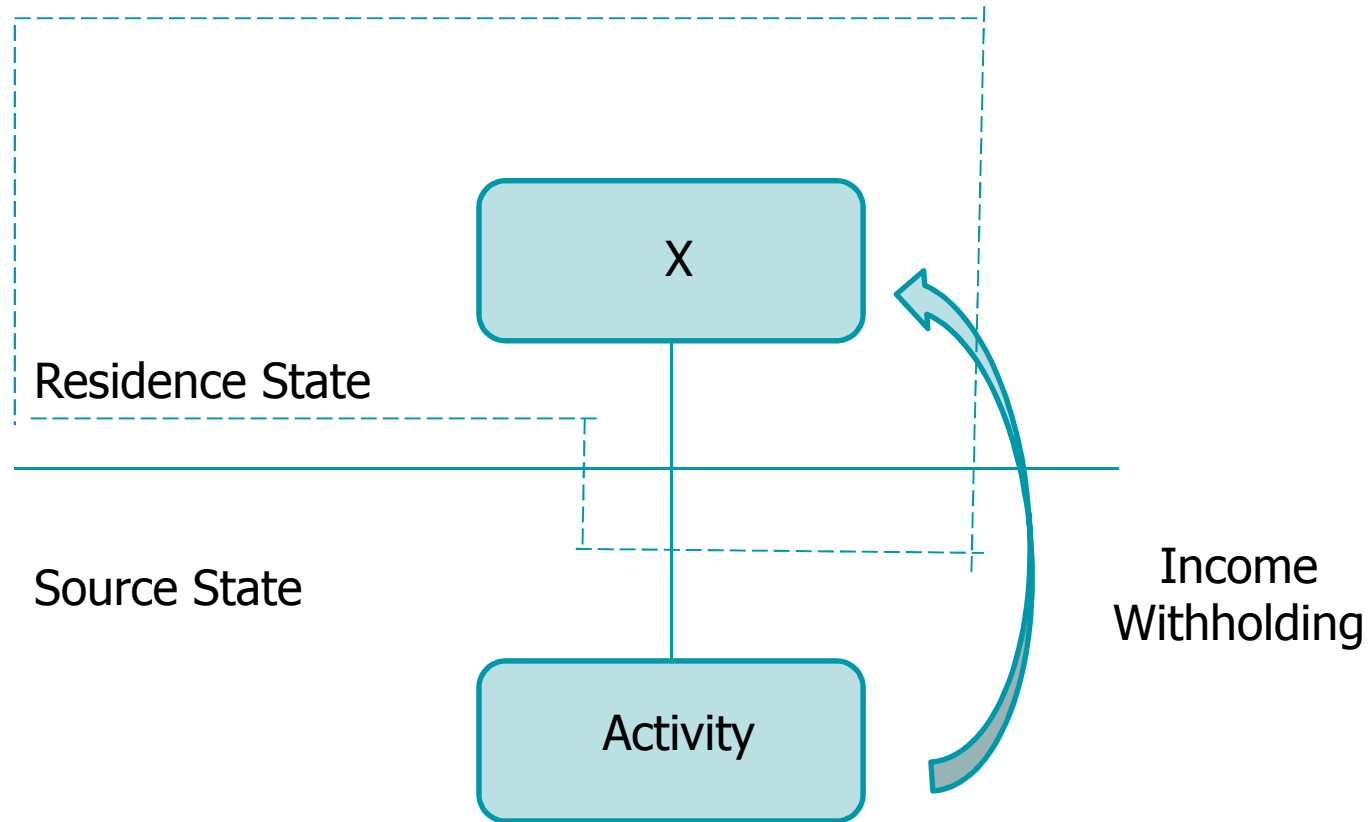

# The Residence Rule: Right to Tax Income



- Right to tax income but give credit/exemption for taxes paid in Source state
- Residence determined under each jurisdictions domestic laws
- Company -
  - a. Incorporation
  - b. Management and control
- Individual -
  - a. Days spent
  - b. Days spent (Singapore, India)
  - c. Home location (France, Italy)



# ALLOCATION OF TAXING RIGHTS

# Allocation of Taxing rights

- Multiple states may have a right to tax
- Taxing rights are allocated between the residence and the source state
- Residence – Source: tax treaty/ domestic law
- Residence – Residence – Tax treaty
- Source – Source : No Solution

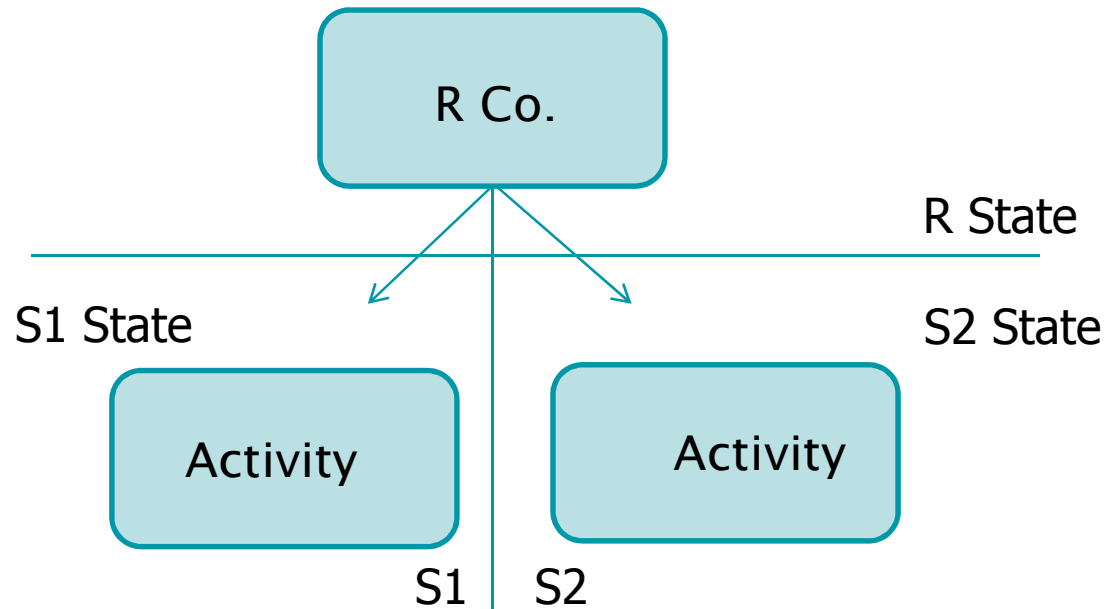



# REDUCING FOREIGN TAX LIABILITY - OECD ARTICLES



# Residence (Art. 1, 4)

- For a tax treaty to apply, entity must be
  - ✓ Receiving the income
  - ✓ Tax resident in one of the jurisdictions
- Under the domestic laws of jurisdictions
  - ✓ Obtain a COR – Management and control?
    - Incorporation?





# What is a Tax Treaty?

- Bilateral/Multilateral agreement to share taxing rights under certain conditions.
- Does not create a tax liability, only restricts a tax liability in a jurisdiction
- Domestic tax laws determine the rate and method of taxation.

# Permanent establishment

- Most tax treaties state that a person is only taxable on business income in the source state, if there is a permanent establishment in the source state (Art. 7)

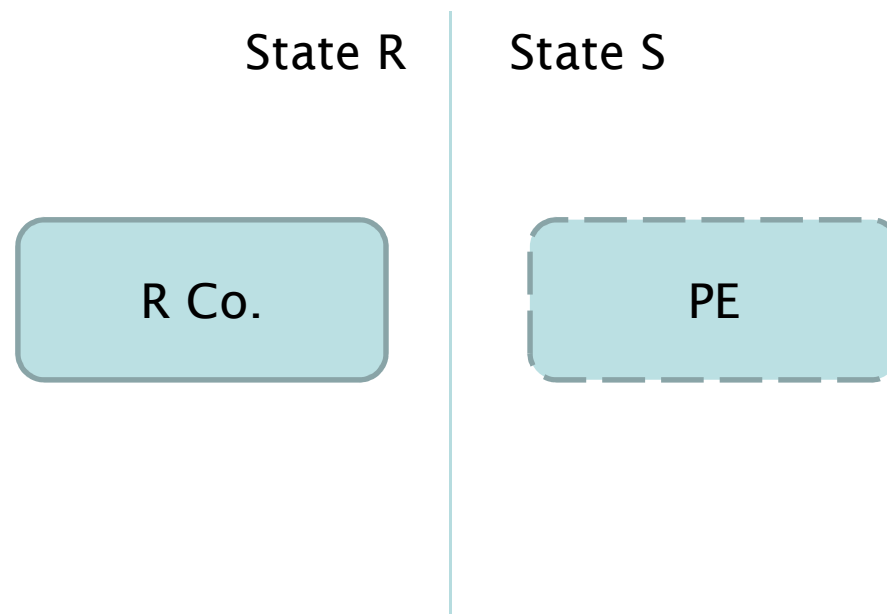

# Permanent establishment

- The treaty in Article 5, outlines 3 factors which must be present for a PE to exist and then considers the question of dependent and independent agent
- Fixed place PE:
  - ✓ A place of business must exist, at disposal of the business
  - ✓ The place of business must be 'fixed' (time and place)
  - ✓ The business of the enterprise in question must be carried on at the fixed place of business

# Permanent establishment

- Agency PE – dependent agent and independent agent – authority to conclude contracts (habitually)

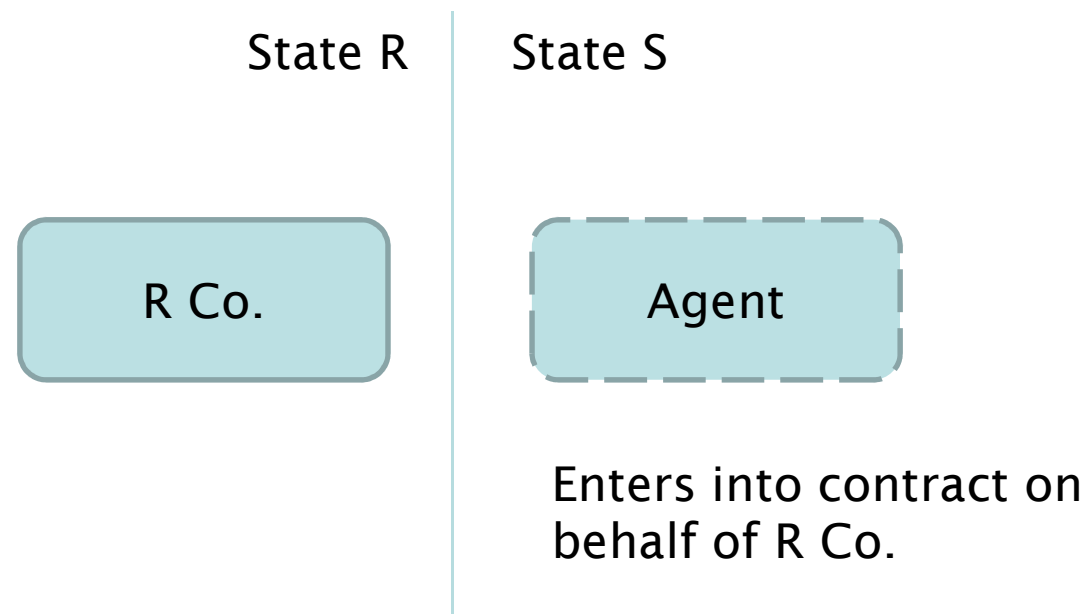

# Permanent establishment

- Service PE – provision of services in source state for a period of 183 days or more

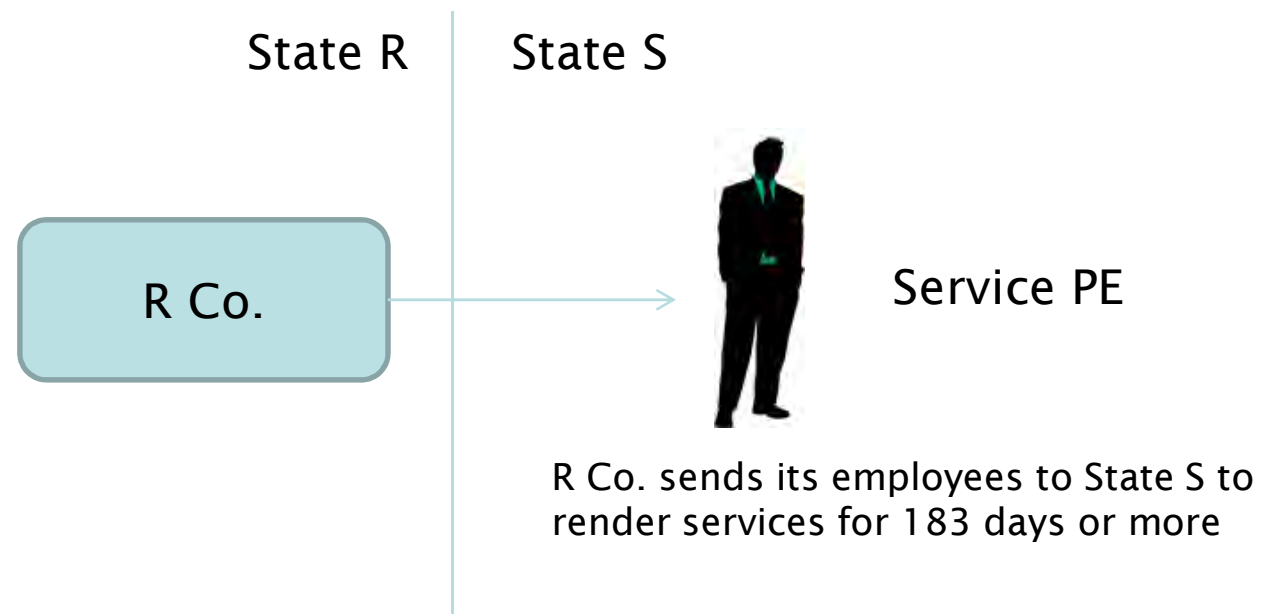



# Dividend- Art. 10

- Beneficial Ownership
- Anti Abuse -
  - ✓ Limitation of Benefits
  - ✓ ↓ Withholding tax if ↑ participation
  - ✓ Main purpose test
- Key: definition

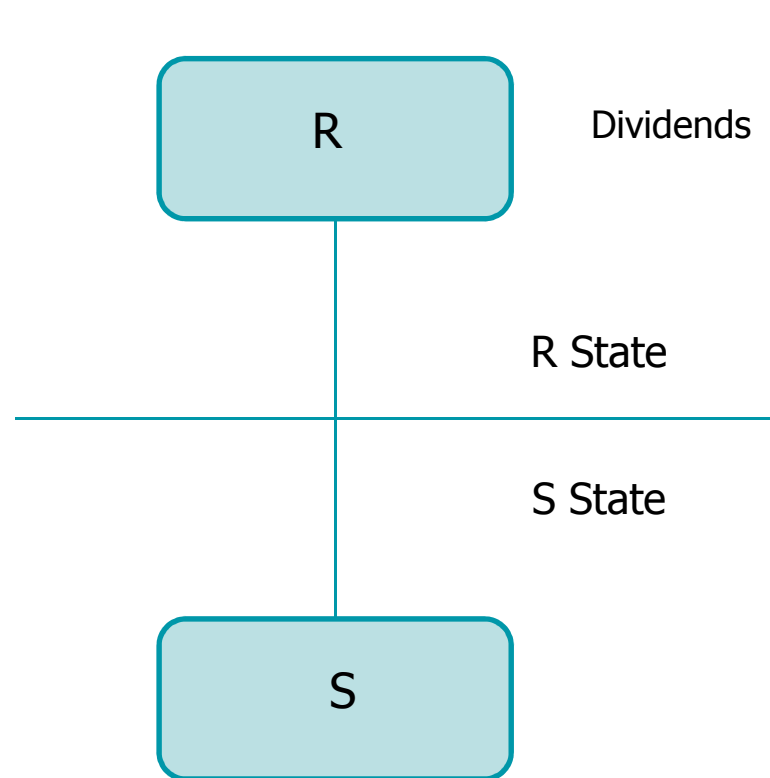

Tax Treaty –  
restricts S state  
withholding tax

# Interest-Art.11

- Beneficial Ownership
- Anti Abuse –
  - ✓ Limitation of Benefits
  - ✓ Excessive Interest
  - ✓ Main purpose test
- Key: definition

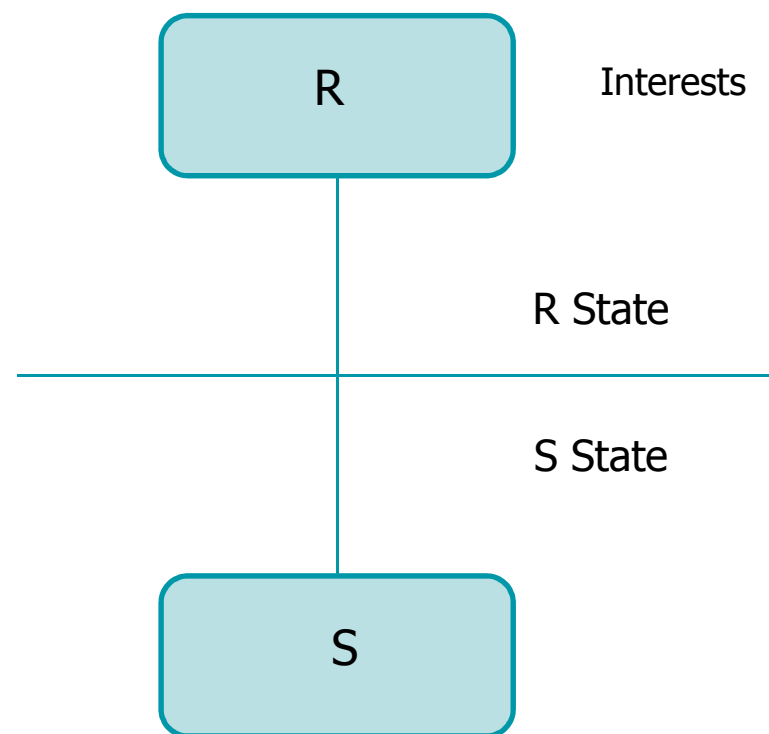

Tax Treaty –  
restricts S state  
withholding tax

# Royalties – Art. 12

- Beneficial Ownership
- Anti Abuse –
  - ✓ Limitation of Benefits
  - ✓ Main purpose test
- Key Definition
- License vs. service (e.g. royalties)

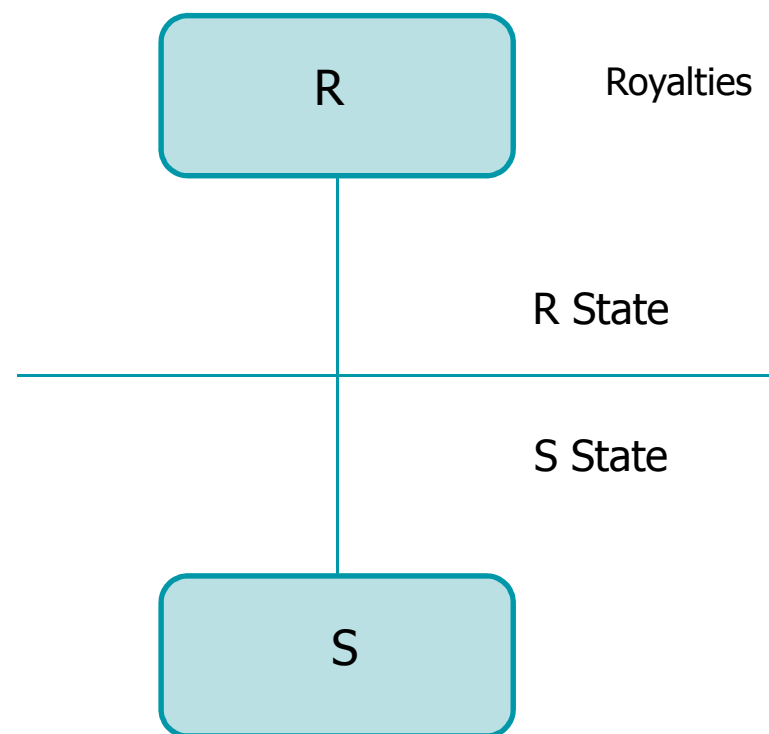

Tax Treaty –  
restricts S state  
withholding tax



# Capital Gains – Art. 13

- Source state is entitled to tax sale of movable property associated with a PE or the PE itself
- Immovable property – S State ∞
- Permanent Establishment – S State ∞
- Land Rich Company - S State ∞
- Other: R State only– India, Thailand

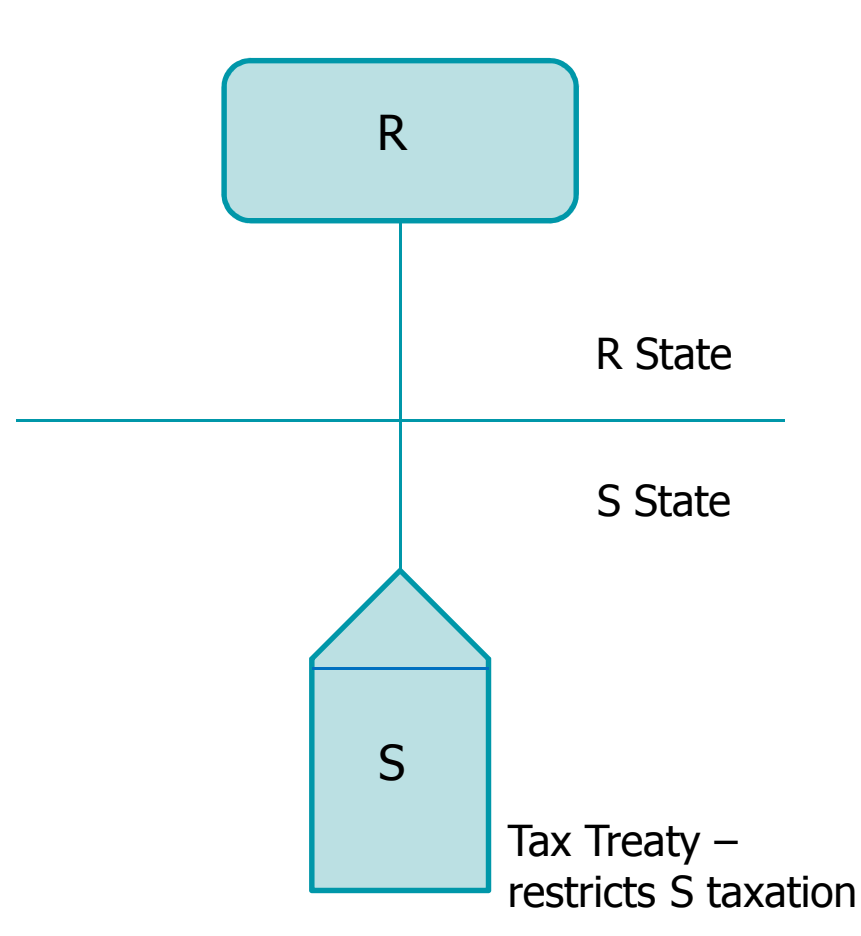

# Income from Employment – Art. 15

- R State has the right to tax unless employment exercised in the S State
- If employment exercised in S State, still taxable in R State if-
  - ✓ Present in S State for less than 183 days
  - ✓ Remuneration paid by employer resident of R State
  - ✓ Remuneration not borne by PE of the employer in S State

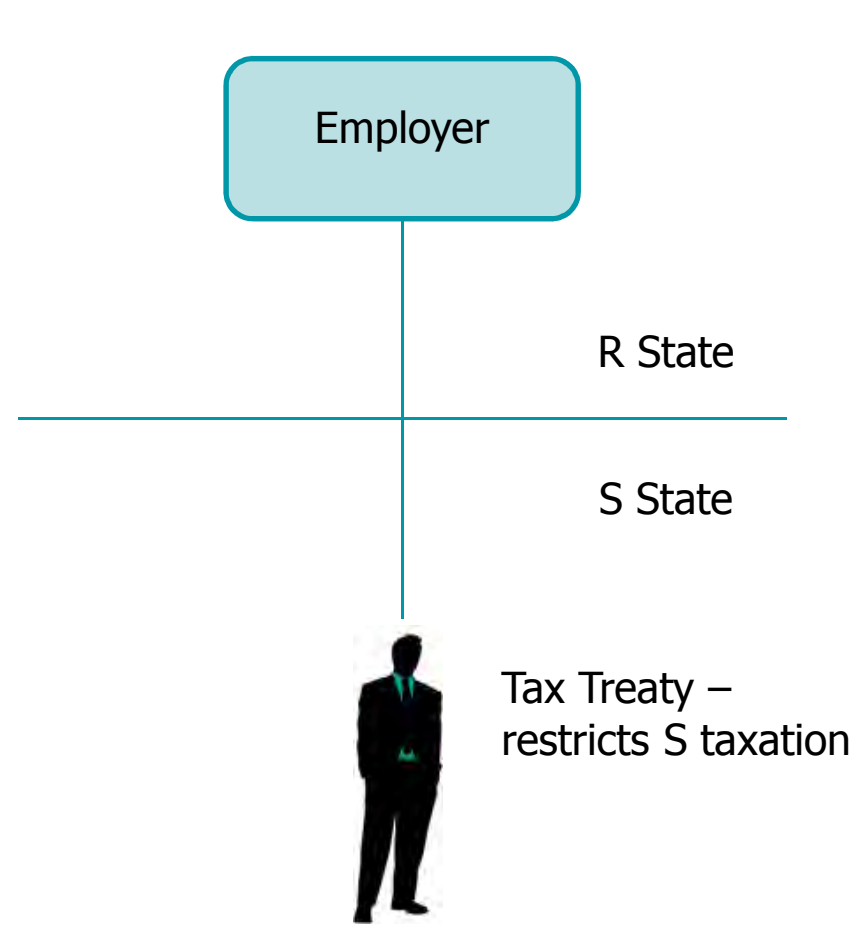

# Director's Fees – Art. 16

- S State has the right to tax
- S State is where the enterprise is located

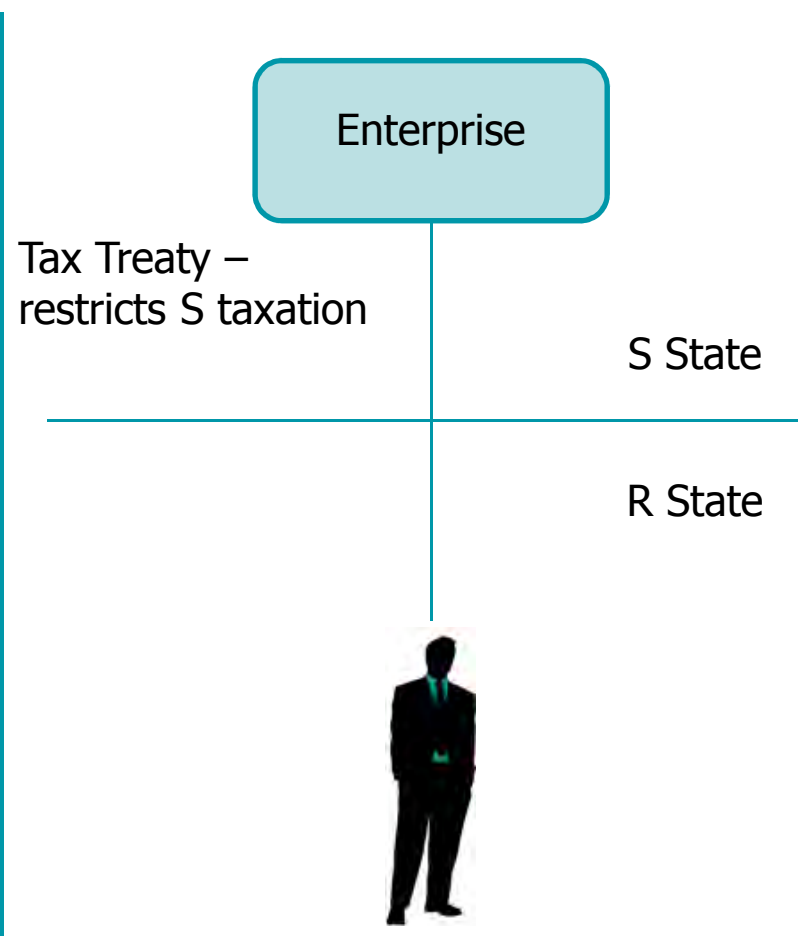



# OTHER MATTERS



# Other Matters

- New Rules (Hybrid entities)
- Fixed old rules [intangibles (TP), E-commerce]
- Increase transparency (country-by-country reporting)
- Render BEPS legal



# Other Matters

- **New Rules**
  - ✓ Required? (change domestic law?)
  - ✓ Treaty shopping?
- **Fixed Old Rules**
  - ✓ ALP still OK
- **Increased Transparency**
  - ✓ Burden on taxpayer Vs. tax authority benefit
    - Multi-lateral instrument – possible?



# OECD – BEPS Project

- Identifies key areas where there are concerns in the international tax system
- Comprises of 15 actions with accompanying timelines
- Can be grouped in four major categories
  - ✓ General actions
  - ✓ Treaty actions
  - ✓ Permanent establishment and transfer pricing
  - ✓ Data and transparency
- BEPS – Thoughts
- Purpose: protect tax bases/ certainty to taxpayers
- New 7 deliverables (September 2014)



# Exchange of Information

- Exchange of Information under bi-lateral treaties (Art. 26 of OECD MC)
- Newly negotiated TIEAs
- EU's Savings Tax Directive
- US's FATCA
- Automatic Information Exchange





# General Anti Avoidance Rules

- Broad rule to catch what the law cannot
- Main criteria – “substance over form”
- Main purpose or one of the main purposes to obtain tax benefit etc.



# Specific Anti Avoidance Rules

- India Singapore Tax Treaty – Art 24 – Limitation of Relief

*“Where this Agreement provides (with or without other conditions) that income from sources in a Contracting State shall be exempt from tax, or taxed at a reduced rate in that Contracting State and under the laws in force in the other Contracting State the said income is subject to tax by reference to the amount thereof which is remitted to or received in that other Contracting State and not by reference to the full amount thereof, then the exemption or reduction of tax to be allowed under this Agreement in the first-mentioned Contracting State shall apply to so much of the income as is remitted to or received in that other Contracting State.*

*2. However, this limitation does not apply to income derived by the Government of a Contracting State or any person approved by the competent authority of that State for the purpose of this paragraph. The term "Government" includes its agencies and statutory bodies.”*



# Controlled Foreign Company Rules

- Conduit Foreign Company Rules
- US CFC Rules – Sub-Part F income – Sec 951 to 965 of the US internal revenue Code
- CFC – corporation having more than 50% voting power of value in the foreign corporation
- Limits referral of certain type of income earned by CFCs – US shareholder must include in their gross income their pro rata share of subpart F income;
- Also disallows deferral of accumulated profits of the CFC attributable to non Subpart F income to the extent to the extent CFC holds investment in US property



# Limitation of Benefits Clause

- LOB clause is an anti-abuse provision which sets out which residents of contracting states are entitled to treaty benefits
- Limits ability of third country residents to obtain treaty benefits – discourages tax treaty shopping
- Most US treaties contain this clause
  - ✓ Active trade or business test
  - ✓ Publically traded business test
  - ✓ Ownership/ base erosion test
  - ✓ Derivative benefits test



# Thin Capitalization Rules

- Prevents potential stripping of income by limiting interest deductions on debt owed to affiliates
- Infusion of more debt vis-à-vis equity
- The company has high loans and hence pays more interest; or
- Interest charged is in excess of ALP; or
- Duration of loan is longer than would be the case at ALP; etc.



# TRANSFER PRICING

# Transfer Pricing

- Provides the methodology of how prices should be charged between related parties;
- Not just the structures but the underlying transactions may also be scrutinized
- Tax authorities conscious of the inter-group pricing policies on domestic taxable profit

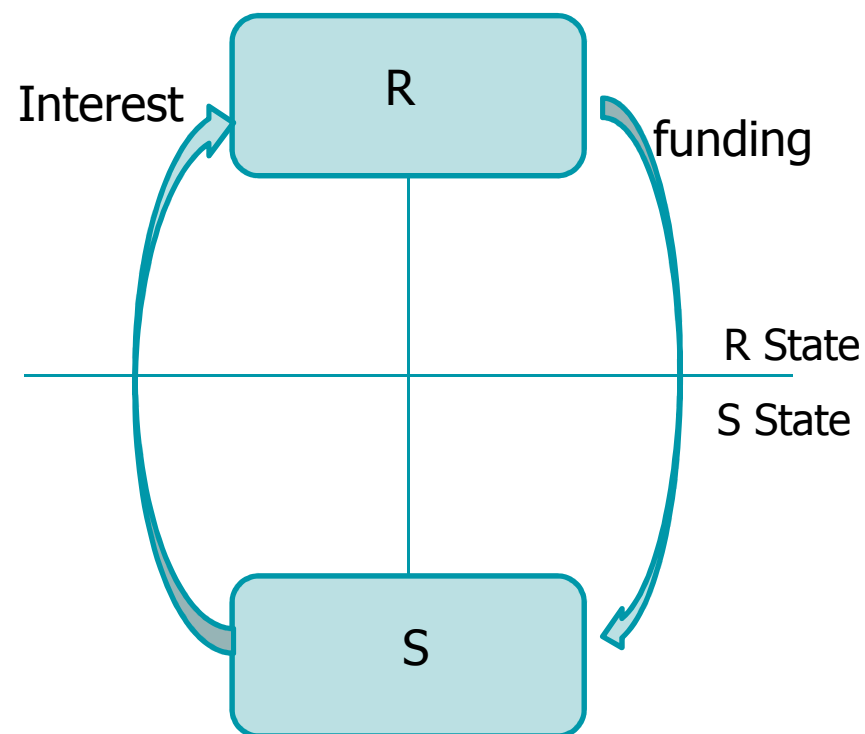

If R State has higher tax rate, may wish to reduce the interest charged.



# Transfer Pricing

- Comparable Uncontrolled Price Method – compares the price charged for properties or services transferred in a related party transaction to the price charged in an independent transaction in a comparable situation
- Cost Plus Method – focuses on gross mark up obtained by a supplier who transfers property or provides services to a related purchaser. A comparable gross mark up is added to the costs incurred by the supplier to arrive at ALP
- Resale Price Method – used when products that have been purchased from a related party are resold to an independent party. Resale price margin is used to arrive at the ALP.
- Transactional Net Margin Method – compares the profit arising from related party transactions with that generated from transactions with independent parties.
- Profit Split Method – used when transactions are highly inter-related and cannot be evaluated separately. Identifies the profit to be split and then splits it based on the contribution of each party involved.





- International & Domestic Tax
- Company Formation & Administration
- Trusts & Foundations
- Immigration & HR
- Funds & Family Offices
- Accounting & Financial Reporting



The insight  
to be your  
trusted  
adviser

### **Sanjay Iyer**

Email      [sanjay@iyerpractice.com](mailto:sanjay@iyerpractice.com)  
Phone      +852 2529 9952  
Mobile      +852 9355 3495

Unit 29E, 29/F Admiralty Centre Tower 1  
18 Harcourt Road, Admiralty  
Hong Kong